

# *Q-Roi RGB Instruction Manual*

# Warning / Precautions!

---



**Warning**

- Do not modify, dismantle or unintended operation this system outside Q-ROI After Sales. Damage occurred by unintended operation may cause Q-ROI After Sales service void.



**Warning**

- Always wear seatbelt. When the vehicle is suddenly stop can cause injury.
- Remove dust, oil, and waste on the display.
- Incidental damages (including, without limitation, consequential damages due to the use of this unit and the dead loss of business profit, changes, loss of memory contents, etc) will not be taken responsibility.
- Any function that requires your prolonged attention should only be performed after coming to a complete stop. Always stop the vehicle in a safe location before performing these functions. Failure to do so may result in an accident.
- The engine is off while the system operates for long time, battery may be discharged.
- This product is not a substitute for your personal judgment. Any route suggested by this navigation system may never supersede any local traffic regulation. Do not follow route suggestions if the navigation system instructs you to perform an unsafe or illegal maneuver.

# 1. Feature

---

- Android Operating system 4.2.2 (Jelly Bean)
- Powerful CPU (1GHz Cortex A9 Dual-Core CPU )
- Support Android Play-Store (Various applications supported)
- High quality video Display (800 x 480, 480 x 234, Composite(CVBS))
- Various Multimedia ports (2\*Video Input, 1\*MIC, 1\*SPK)
- Multiple ways to store data and communication ports  
(5\*USB 2.0, 1\*SDHC Slot)
- Support 3G WCDMA/CDMA2000/TD-SCDMA via 3G Dongle or smart phone  
wifi hot spot
- Quick application launching via car OEM knob (different by car models)

## 2. General Spec

---

OS	Android 4.2.2 (Jelly Bean)
CPU	Telechips TCC8930 (1GHz Cortex A9 DualCore)
Display	OEM LCD
Internal Memory	DDR3 1GB RAM + 8GB eMMC
External Memory	SDHC Slot Support (up to 64GB)
Function	Video Input x 2, Mic x 1, External Speaker x 1 (mono), External Audio Out x 1(Car Aux),
Output	RGB (thru Sub-Board) Composite(CVBS)
Touch Type	Resistive Touch
GPS	SiRF
Resolution	800*480 or 480*234
USB	USB 2.0 x 5 (USB x 4, OTG USB x 1)
Input Voltage	12V
Temperature	operating 0 C to 60 C
	Storage -20 C to 60 C
Languages	multi-languages

# 3. System Diagram

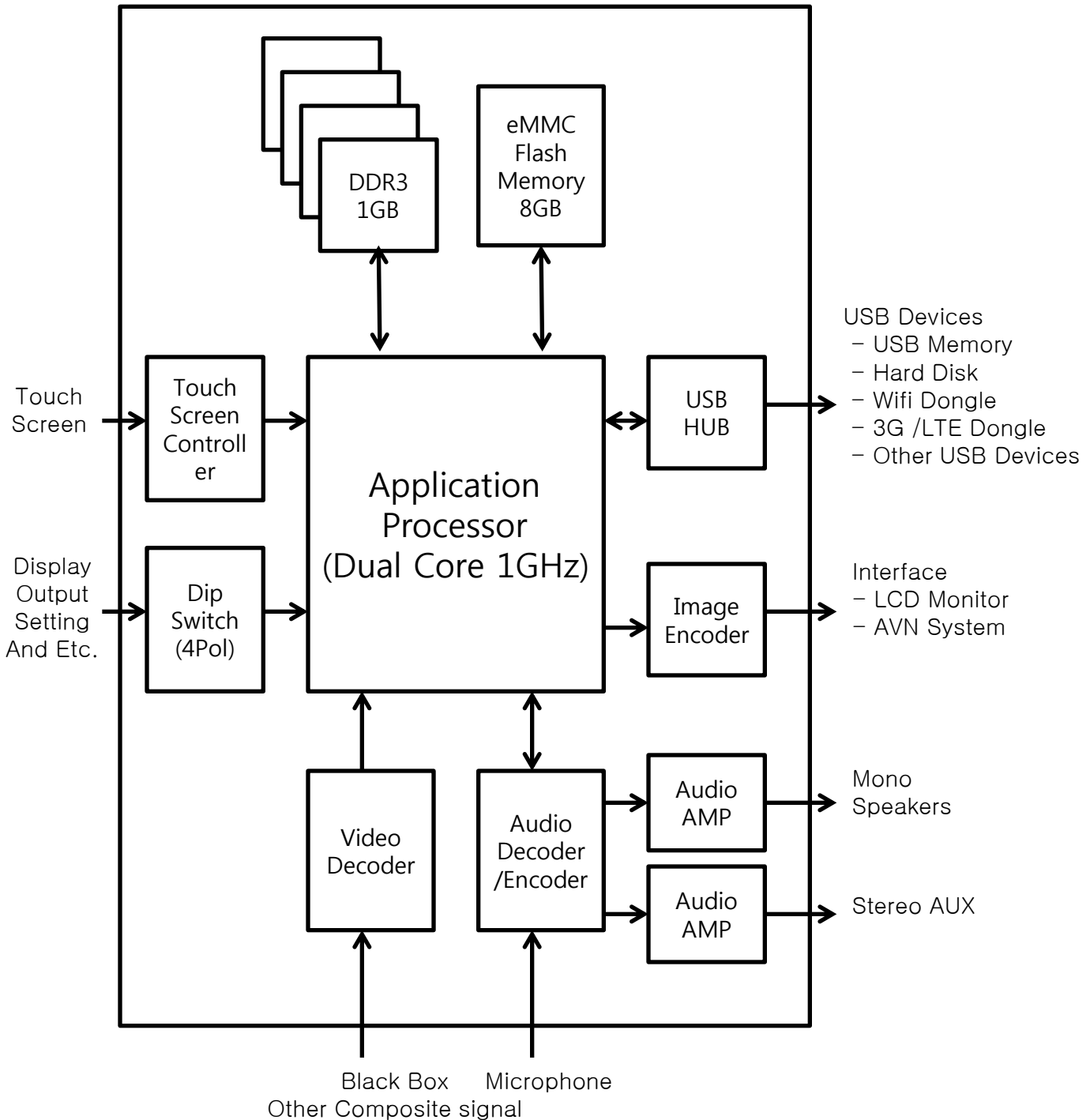

# 4. Components

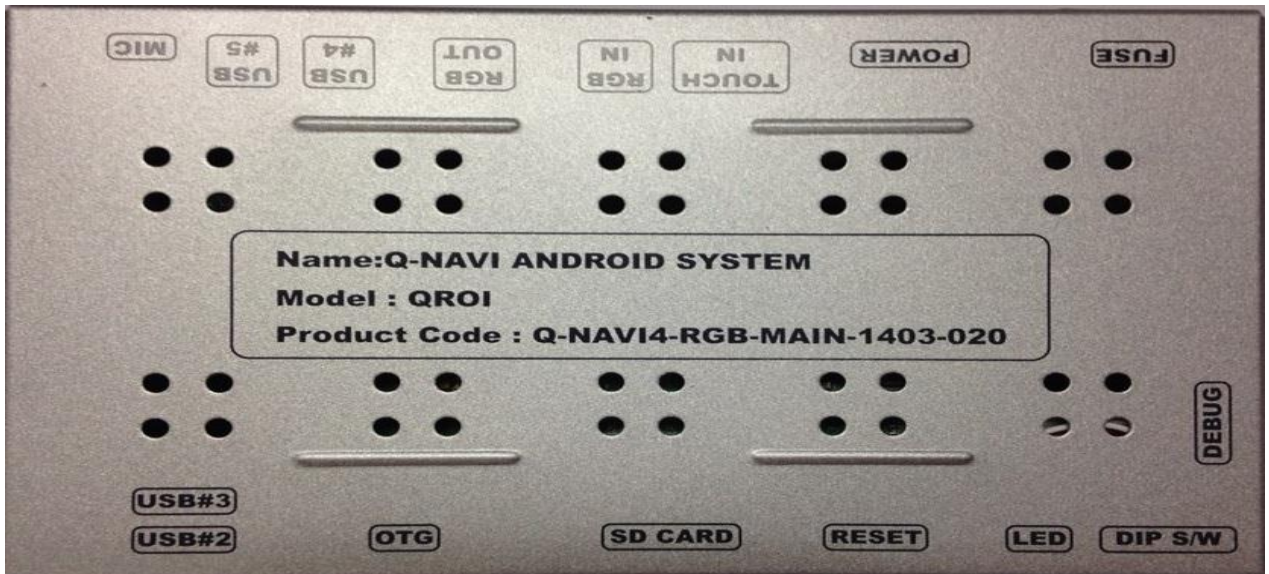

# 5. System Diagram

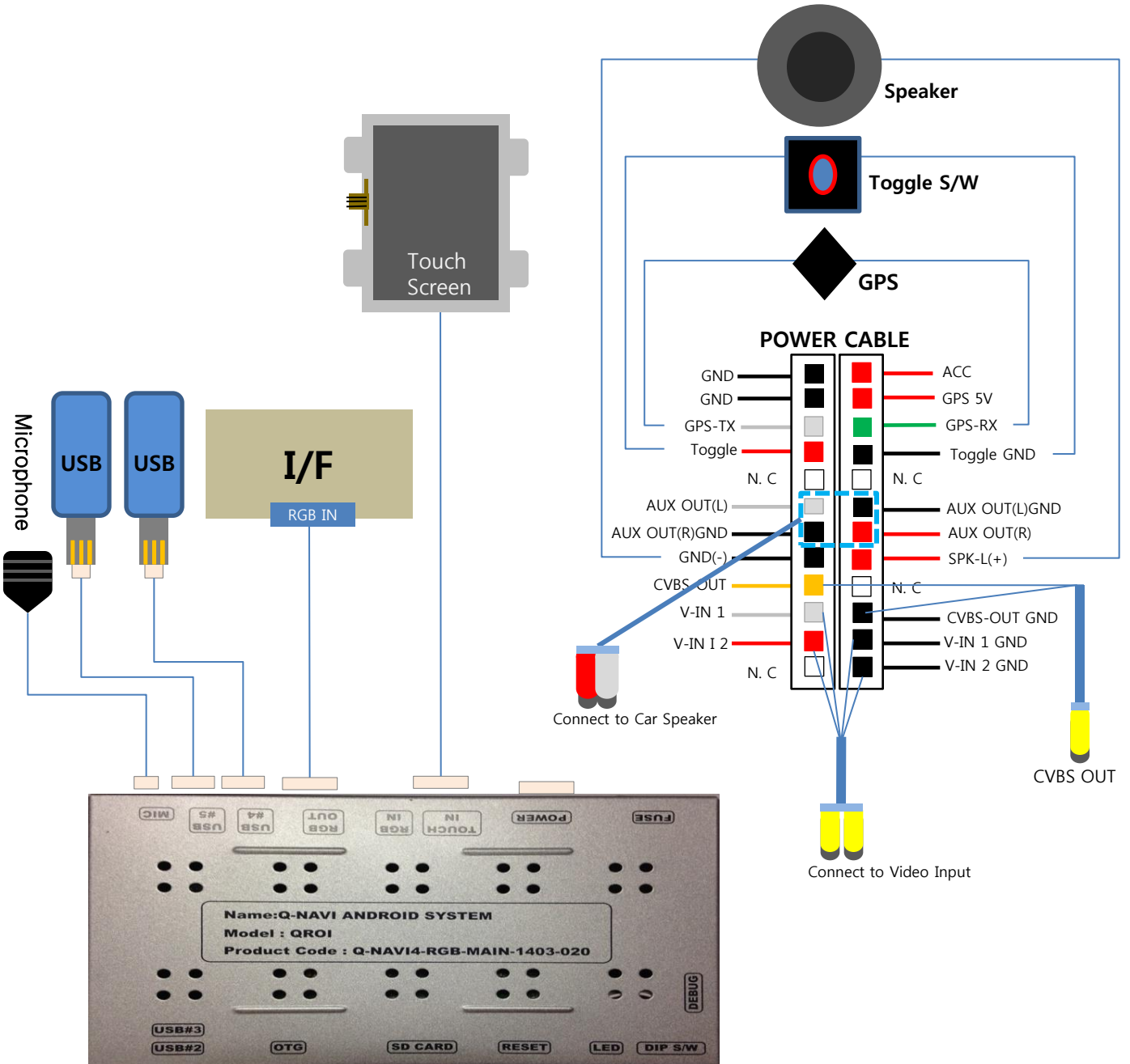

# 6. How to use (Q-Launcher)

## 6.1 Home Screen

※ When Q-ROI system booted up, this screen below appears.

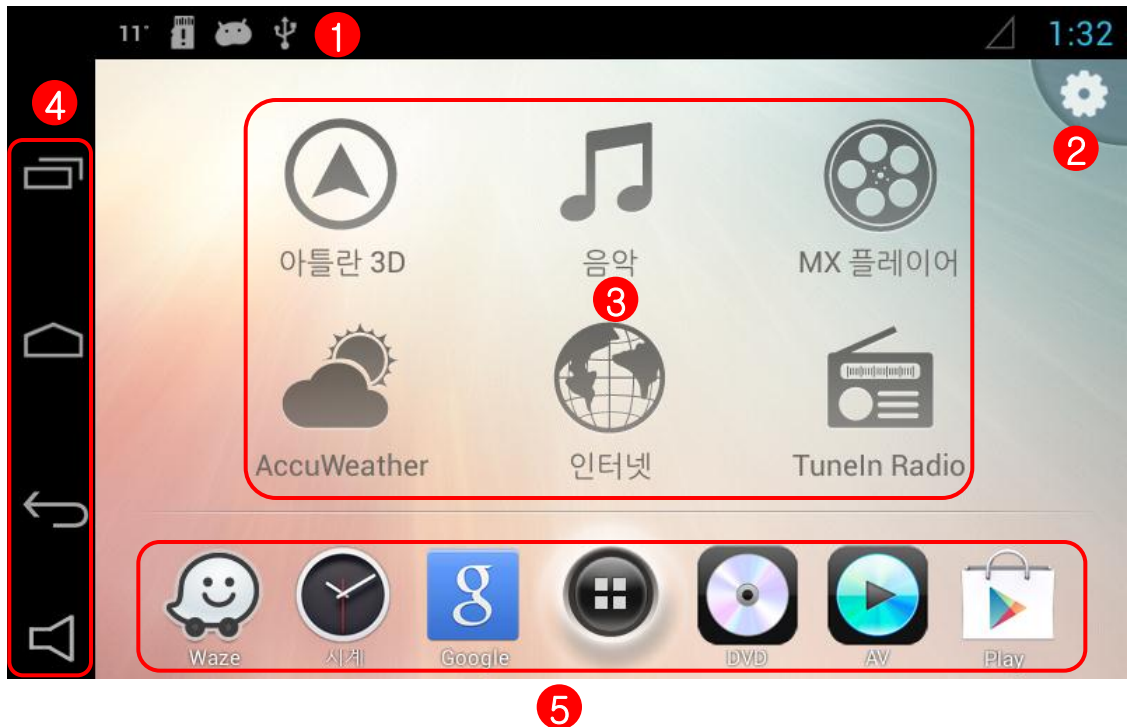

① Status alter bar

② Q-ROI Setting

③ Main Icon : In the main screen of Q-Launcher, there are mainly 6 Icons (applications) that driver will be used to use while driving, user can change preferred applications for these icons.)



# 6. How to use (Q-Launcher)

---

## ④ Navigation Bar

 : (Recent App) : User can see running applications and manage them.

 : (Home Key): Back to Home screen,  
(Long press and dragging to right) Google Now Launching.

 : Back

 : Sound setting

## ⑤ Favorite apps

User can put favorite applications to launch quickly.

 : (App drawer) See all applications in the system

# 6. How to use (Q-Launcher)

## 6.2 Main Apps change

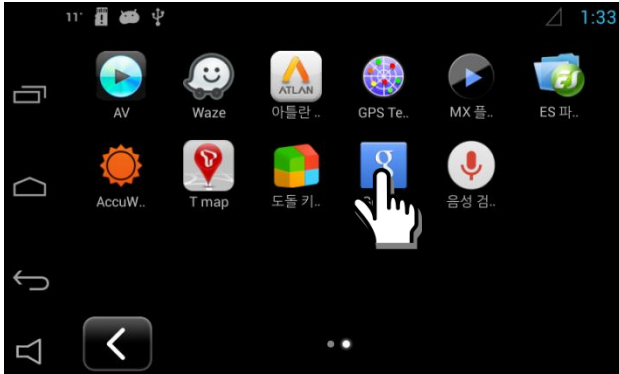

1. Long press your desired app in app drawer

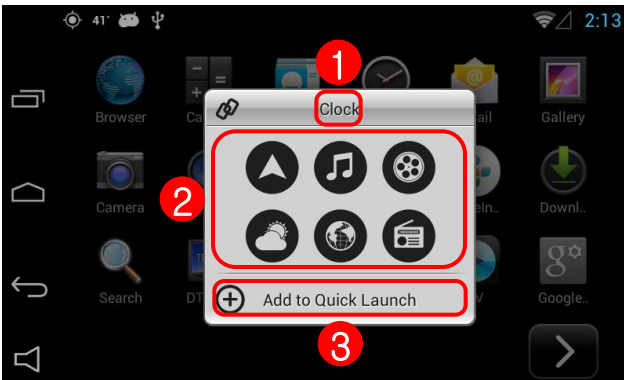

### 2. App change window

- ① Selected app name appears at the top of window.
- ② Choose one icon of main icon that your target app wants to be linked with.
- ③ Press “ADD to Quick Launch” to save your app to main screen.

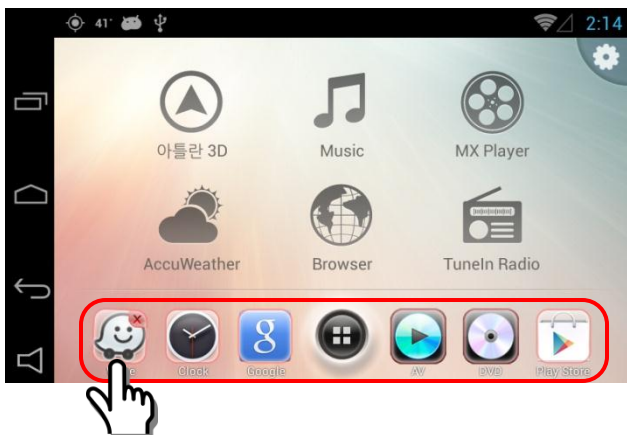

### 3. Favorite Apps icon move and removal

- Long press one of target icon, then X mark appears.
- Press one more time on X mark to remove your target icon
- Drag the target icon to your desired position.

# 6. How to use (Q-Launcher)

## 6.3 Side Bar Usage

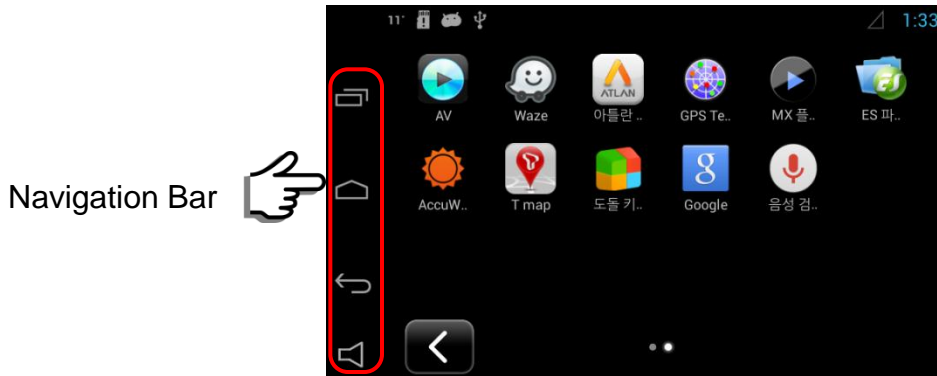

: User can see running applications and manage them.

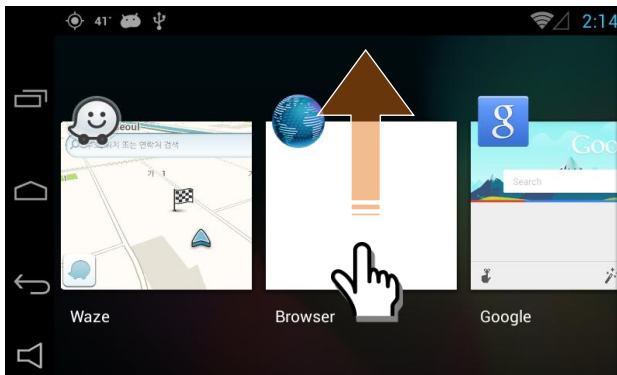

- Once user press this button, all running apps appear.
- User can choose an app to switch
- User can remove apps by dragging up

2.  : Short Press – Back Home , Long Press and dragging it to right –Google Now



# 6. How to use (Q-Launcher)

---

3.  (Back Key) : Return to previous screen

4.  : Q-ROI Volume control and On/Off setting of Q-ROI external speaker

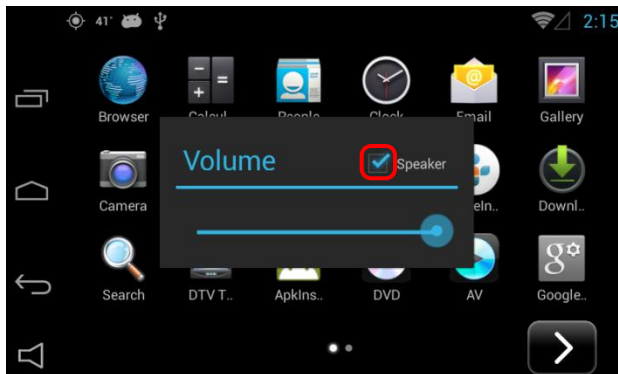

- Once press this button, Sound window pops up.
- User can set on and off of external Speaker  
ON : Enable external speaker  
OFF : Only sound comes from car speaker (AUX)

# 7. Setting

## 7.1 Wi-Fi ON / OFF

※ Q-ROI gets Internet via Wi-Fi dongle from Wi-Fi AP or Mobile Hot Spot.

 App drawer ▶  setting ▶ Wi-Fi

Or simply press Setting button  in the main screen ▶ Wi-Fi

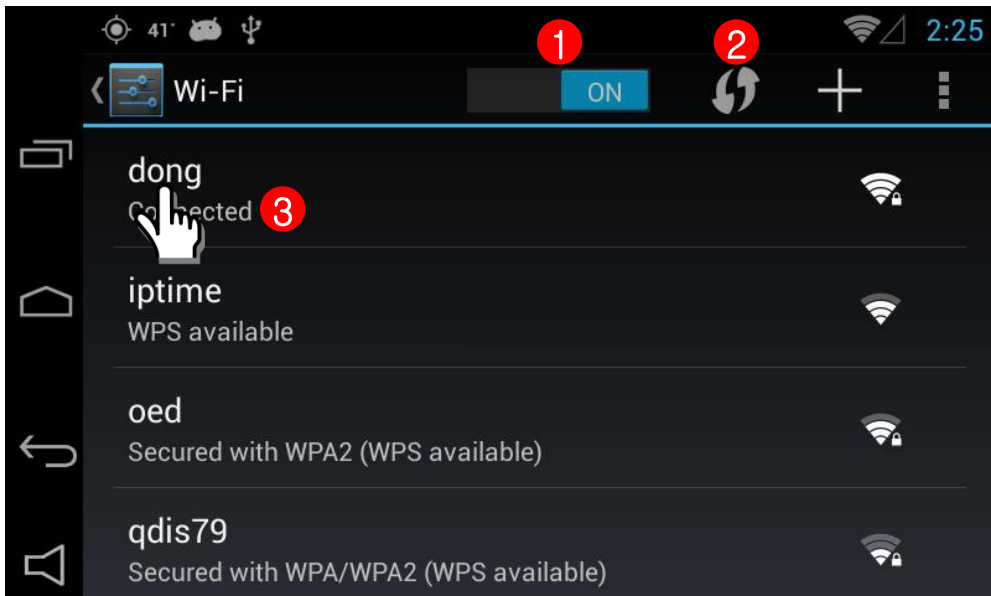

① Wi-Fi ON/OFF

② Reload

Wi-Fi Network search.

③ Connected

Shows currently connected Wi-Fi network, with long press, user can see the status

# 7. Setting

## 7.2 Display

 App drawer ►  setting ► Display

Or simply press Setting button  in the main screen ► Display

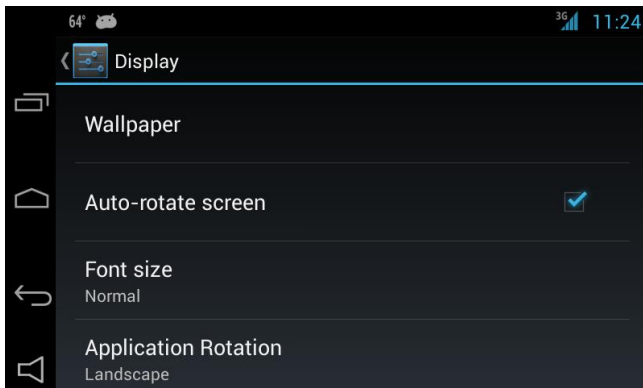
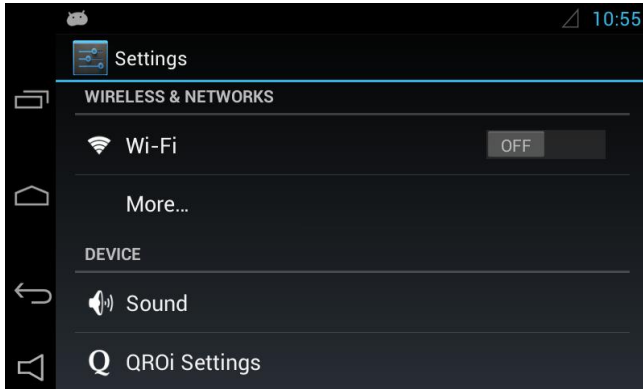

- Auto-rotate screen : the screen automatically updates when you rotate the phone

  - ☞ Tap Auto rotate screen to enable or disable the setting

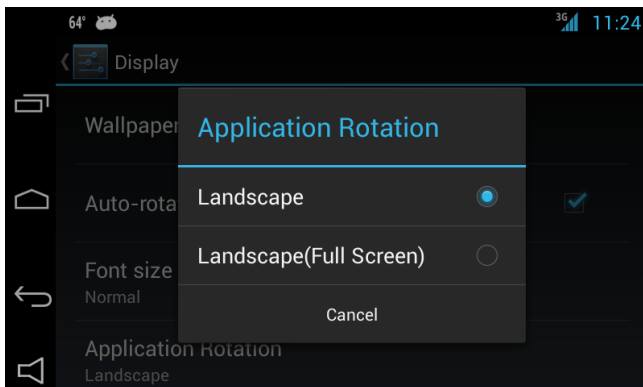

- Application Rotation : user can choose displayed application rotation as Landscape, Landscape(Full Screen)

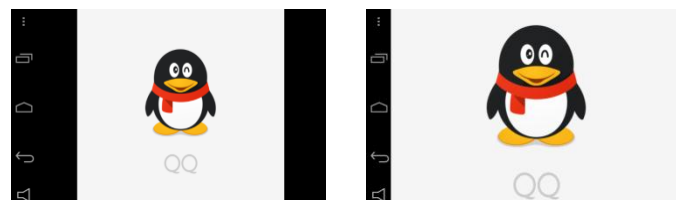



<Landscape>

<Landscape full screen>

# 7. Setting

---

## 7.3 Touch Calibration

 App drawer ►  setting ► QROi Settings ► Touch Calibration  
OR  
Long press toggle switch for 5seconds.



•Touch Calibration.



•Press each target position by a finger nail.

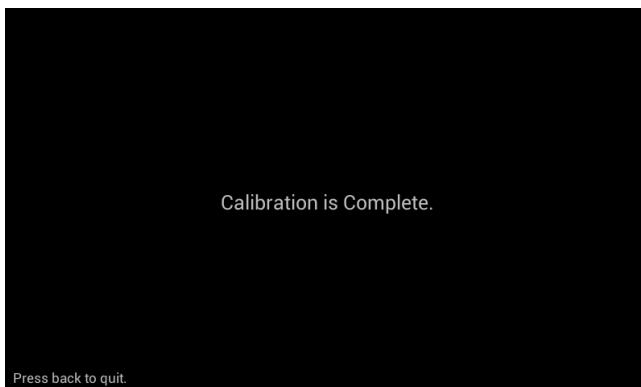

•Completed.

# 7. Setting

## 7.4 RGB

App drawer ► setting ► Q-ROi Settings ► Display setting

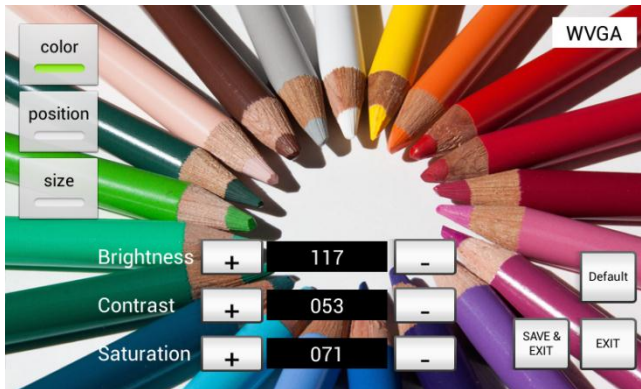

👉 Please make sure to select save and exit after you set up color or position or size.

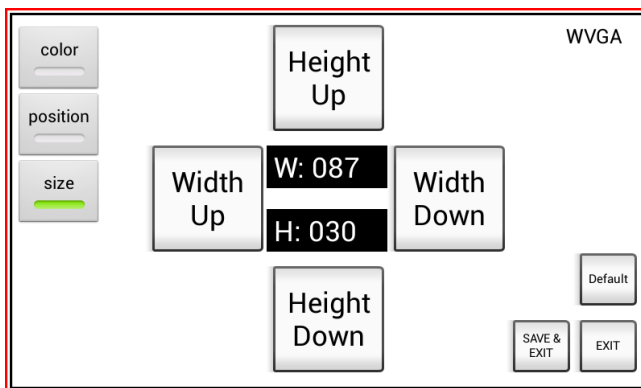
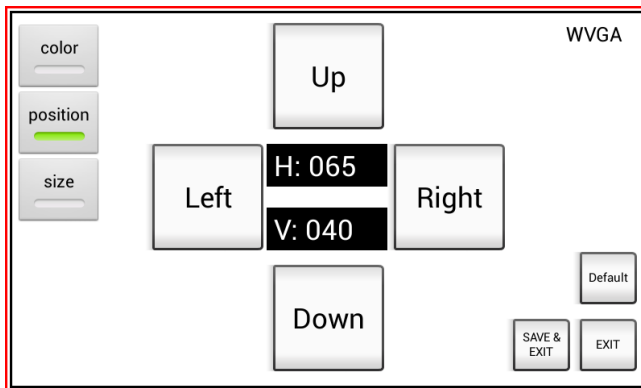



# 7. Setting

## 7.5 Application Management

 App drawer ►  setting ► Apps

Or simply press Setting button  in the main screen ► Apps

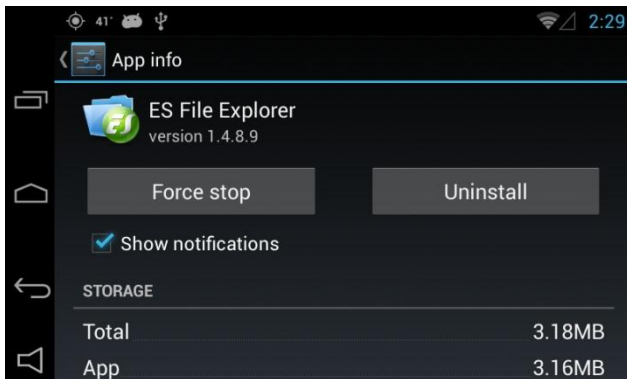
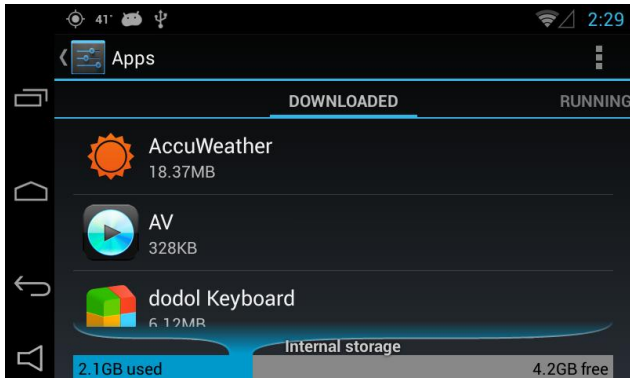

•User can manage (Force stop, Uninstall) applications.

# 7. Setting

## 7.6 System update

Apps ► Settings ► About QROI  
Or Press  ► About QROI

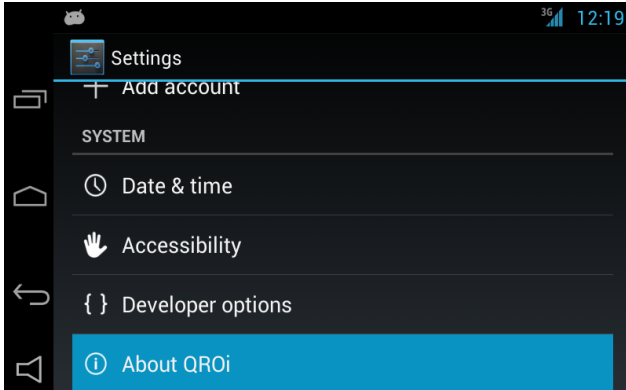

•Select 'About QROI'.

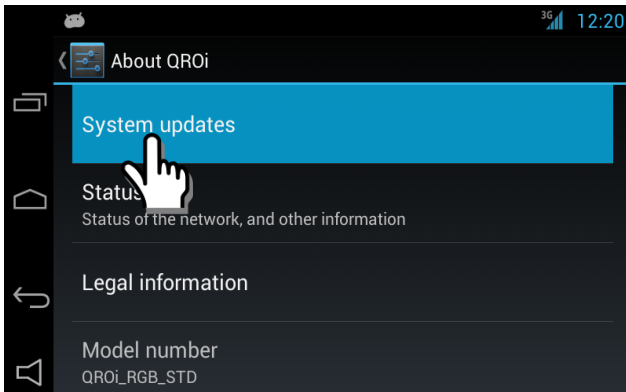

•Select 'System update'.

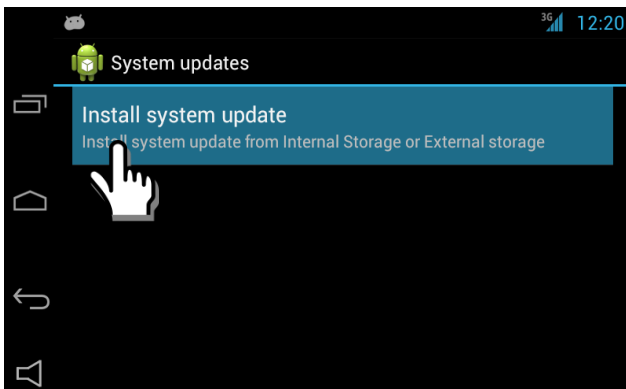

• Select 'Install system update'.  
(update.zip)

# 7. Setting

## 7.6 System update

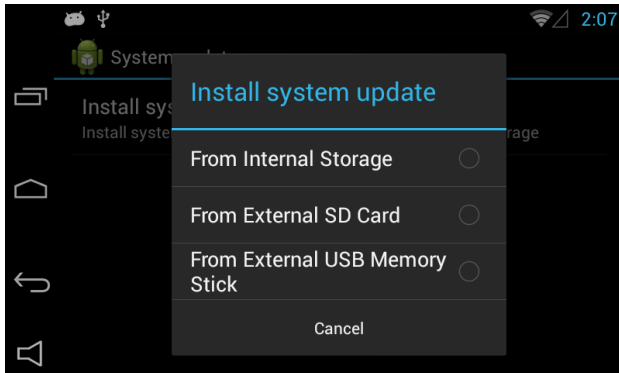

- Select where update file is (Default : From External SD Card)

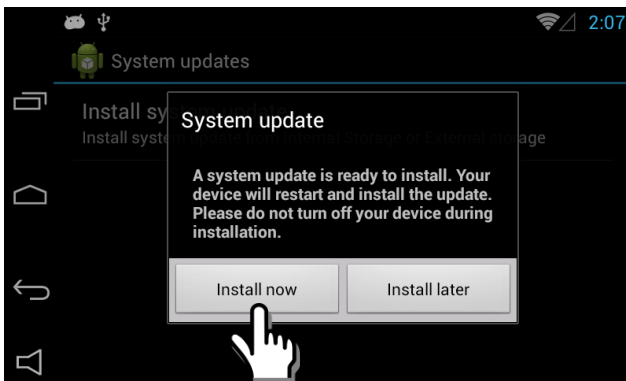

- Select 'Install now'

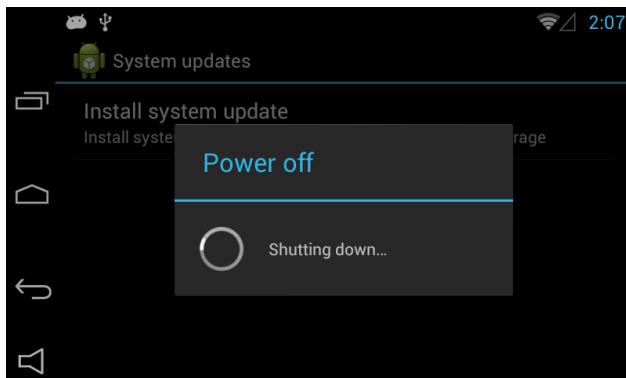

- Update will be started after power off.

# 7. Setting

---

## 7.6 System update

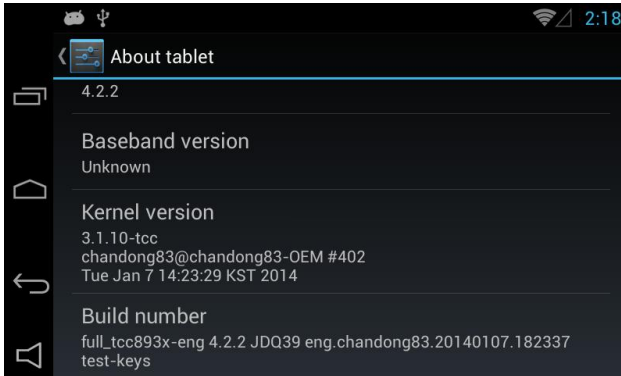

- Check the version of Kernel.

# 7. Setting

---

## 7.6 Dip Switch



ON : Low

OFF: High



CVBS Output



Low Resolution Output



High Resolution Output

※ Please make sure to disconnect the power cable of the interface and reconnect the power cable again to apply the dip switch setting whenever changing DIP switch. Otherwise, DIP switch setting will not be applied.

# 8. Quality Warranty

---

This product has been tested and have passed under our strict quality control. If the failure occurred due to the carelessness of workmanship within one year after the purchase, we are responsible to repair free of charge.

Please bring this warranty to dealer whom you purchased this product from at the repair time. Should this warranty not presented, repair charged will be on customer. Please keep this warranty card.

Warranty			
Product name	QROI		
Warranty period	1 year	Purchase date (yy/mm/dd)	
Customer	Address		
	TEL		
	Name		
Dealer	Address		
	Name		